

# MQ 100L

## THREE-WAY COLUMN LOUDSPEAKER

### DESCRIPTION

MQ 100L (available in black and white) is a 3 way column loudspeaker providing natural hi-fi delity sound of both speech and music, suitable for sound system having fixed loudspeakers where the environment is acoustically critical or with architectural constraints.

The wide horizontal coverage angle (180°) and the vertical dispersion (60°) allow the correct sound reproduction in a wide space, in order to limit feedback and improve the sound directivity which is important, for instance, in halls having a long reverberation time. The mounting accessories are included. These have been engineered to keep the column as close as possible to the wall and simplify the installation. Its tilt angle can be chosen among 0° - 5° - 10°. The 60° vertical dispersion is asymmetric: it is the difference between 20° upwards and 40° downwards. The vertical dispersion axis is in fact already angled 10° downwards, making it unnecessary to tilt the sound column excessively.



### FEATURES

- 2 x 3.5" woofer, 2 x 3.5 midrange and 2 x 0.75 dome tweeter
- Power selectable (100 V): 40 W - 20 W - 10 W - 5 W
- 93 dB sensitivity
- Colour white RAL 9016 and black RAL 9005
- Plastic body, steel grille

## TECHNICAL SPECIFICATIONS

<b>Acoustical specifications</b>	Frequency Response (-10dB):	130 Hz ÷ 20000 Hz
	Max SPL @ 1m:	112 dB
	Horizontal coverage angle:	180°
	Vertical coverage angle:	60°
	System Sensitivity:	93 dB
<b>Power section</b>	Nominal Impedance (ohm):	16 ohm
	Power Handling:	80 W RMS
	Peak Power Handling:	320 W PEAK
	Recommended Amplifier:	160 W
	Protections:	PTC on tweeter
	Crossover Frequencies:	2000 Hz
<b>Transducers</b>	Dome Tweeter:	2 x 0.75"
	Midrange:	2 x 3.5"
	Woofers:	2 x 3.5"
<b>Input/Output section</b>	Input connectors:	Euroblock
	Output connectors:	Euroblock
	Constant Voltage Transformer:	100 V
	Power selection 1 (100 V):	40 W - 250 ohm
	Power selection 2 (100 V):	20 W - 500 ohm
	Power selection 3 (100 V):	10 W - 1000 ohm
	Power selection 4 (100 V):	5 W - 2000 ohm
<b>Standard compliance</b>	CE marking:	Yes
<b>Physical specifications</b>	Cabinet/Case Material:	Plastic
	Hardware:	Wall mount bracket
	Grille:	Steel
	Color:	White - RAL 9016
<b>Size</b>	Height:	500 mm / 19.69 inches
	Width:	120 mm / 4.72 inches
	Depth:	167 mm / 6.57 inches
	Weight:	2.73 kg / 6.02 lbs
<b>Shipping informations</b>	Package Height:	550 mm / 21.65 inches
	Package Width:	180 mm / 7.09 inches
	Package Depth:	180 mm / 7.09 inches
	Package Weight:	4.8 kg / 10.58 lbs



**PART NUMBER**

• **13000187**

MQ 100L W

White - RAL 9016

EAN 8024530006570

• **13000186**

MQ 100L B

Black - RAL 9005

EAN 8024530006563

**DRAWINGS**

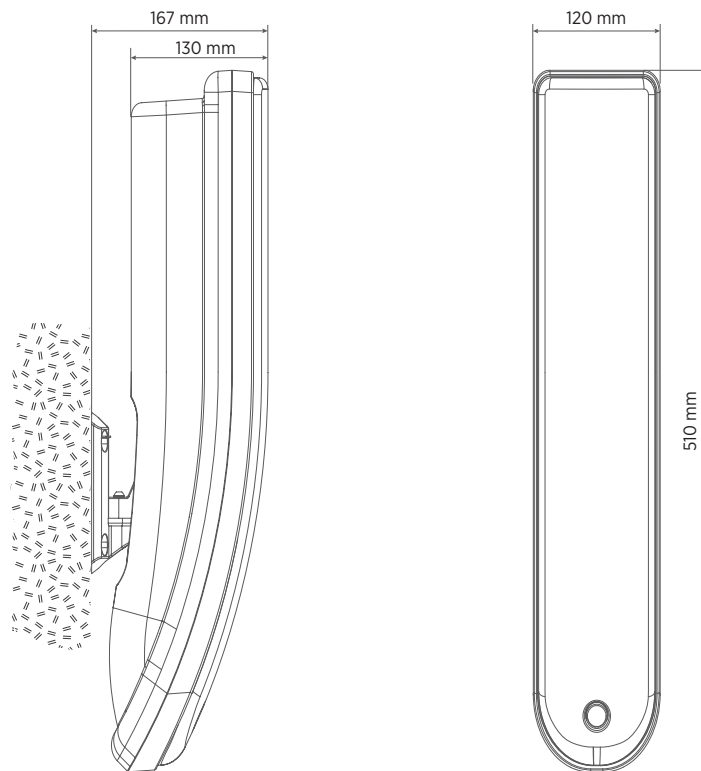

**INSTALLATION**

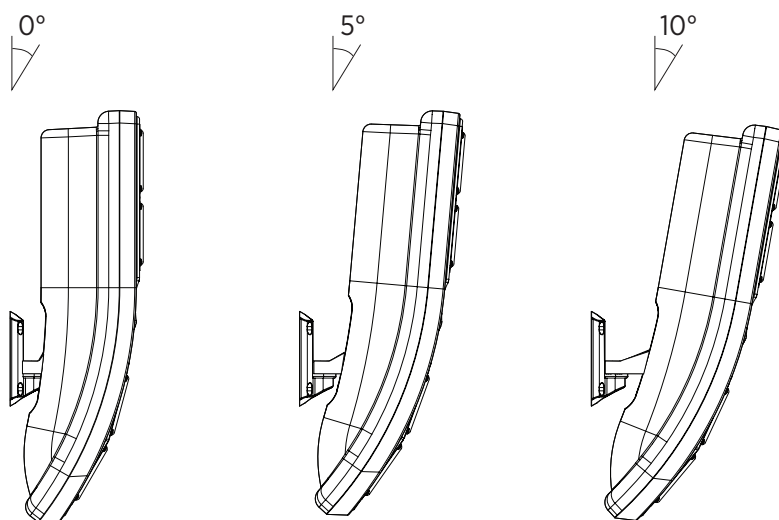

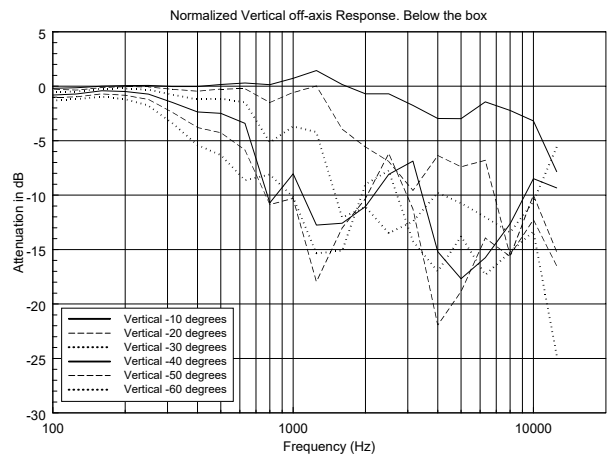
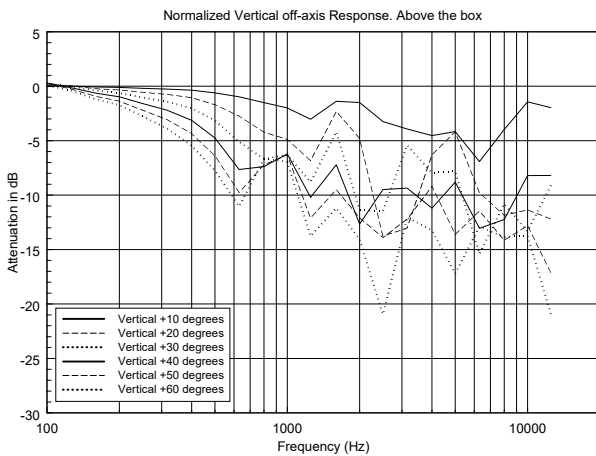
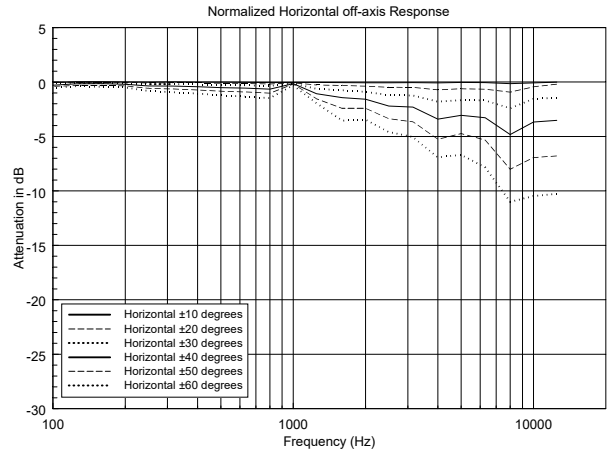
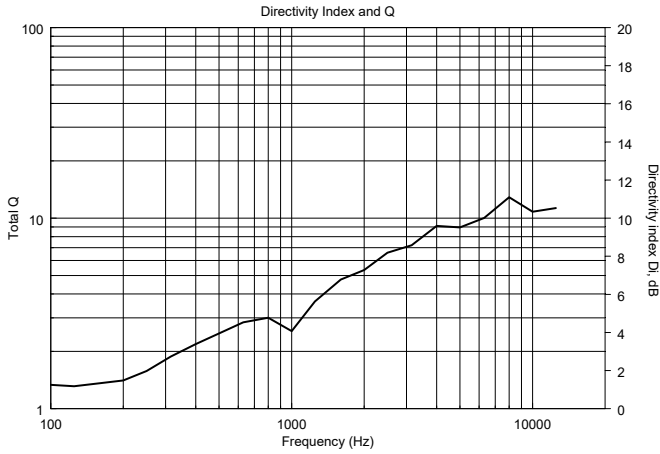
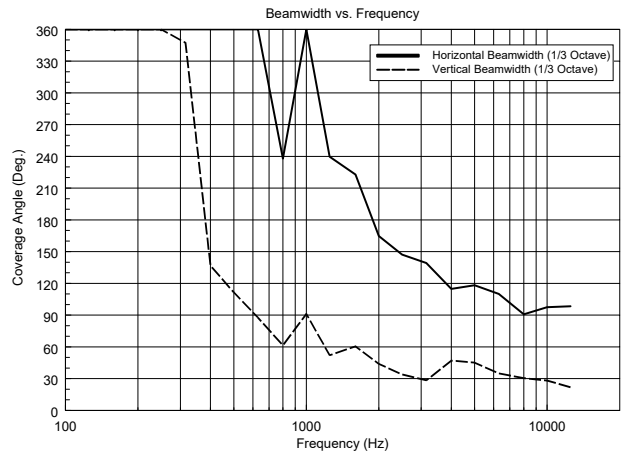
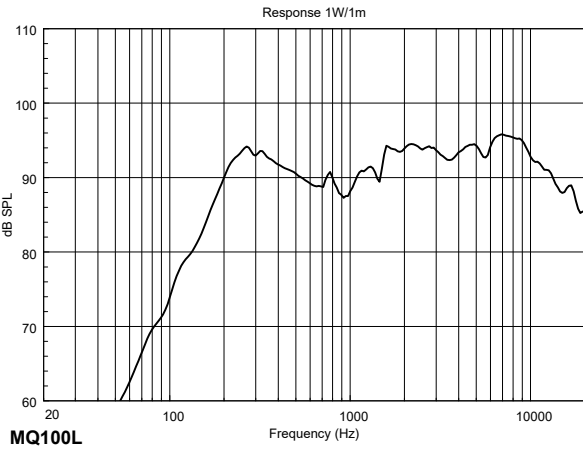

HORIZONTAL 1/3 POLAR PLOT

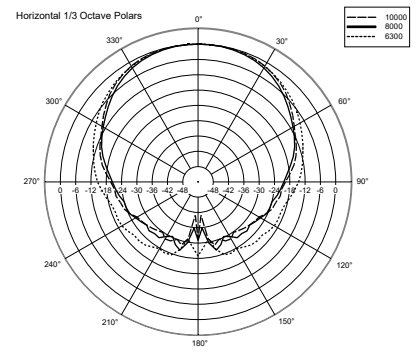
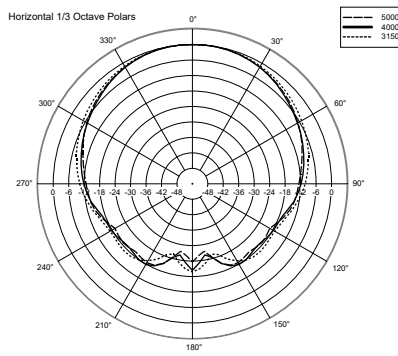
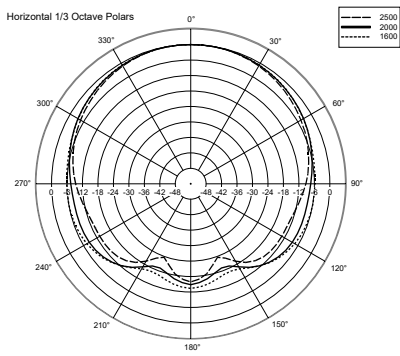
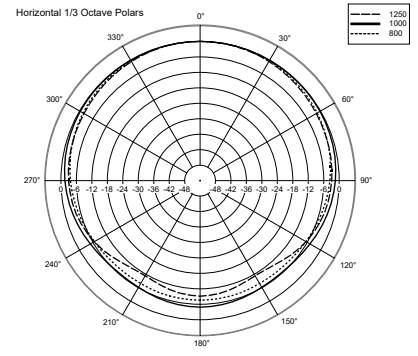
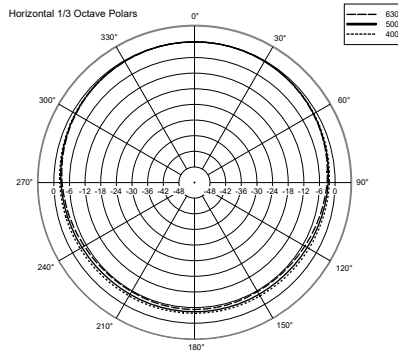
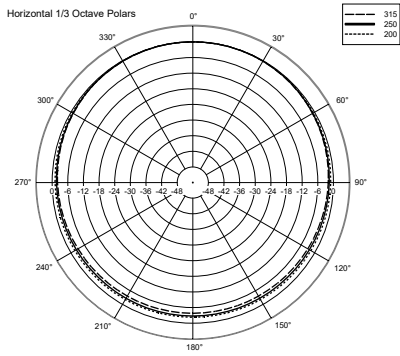

VERTICAL 1/3 POLAR PLOT

